

CUADRO DE SUPERFICIES

SUPERFICIES ÚTILES

Sala de trabajo	12,10m ² .
Armario	0,85 m ² .
Baño	1,55 m ² .
C°. Inst.	0,70 m ² .

15,20 m².

MÓDULO PROFESIONAL: 15,20 m².

Total Superficie MÓDULO: 18,00 m².

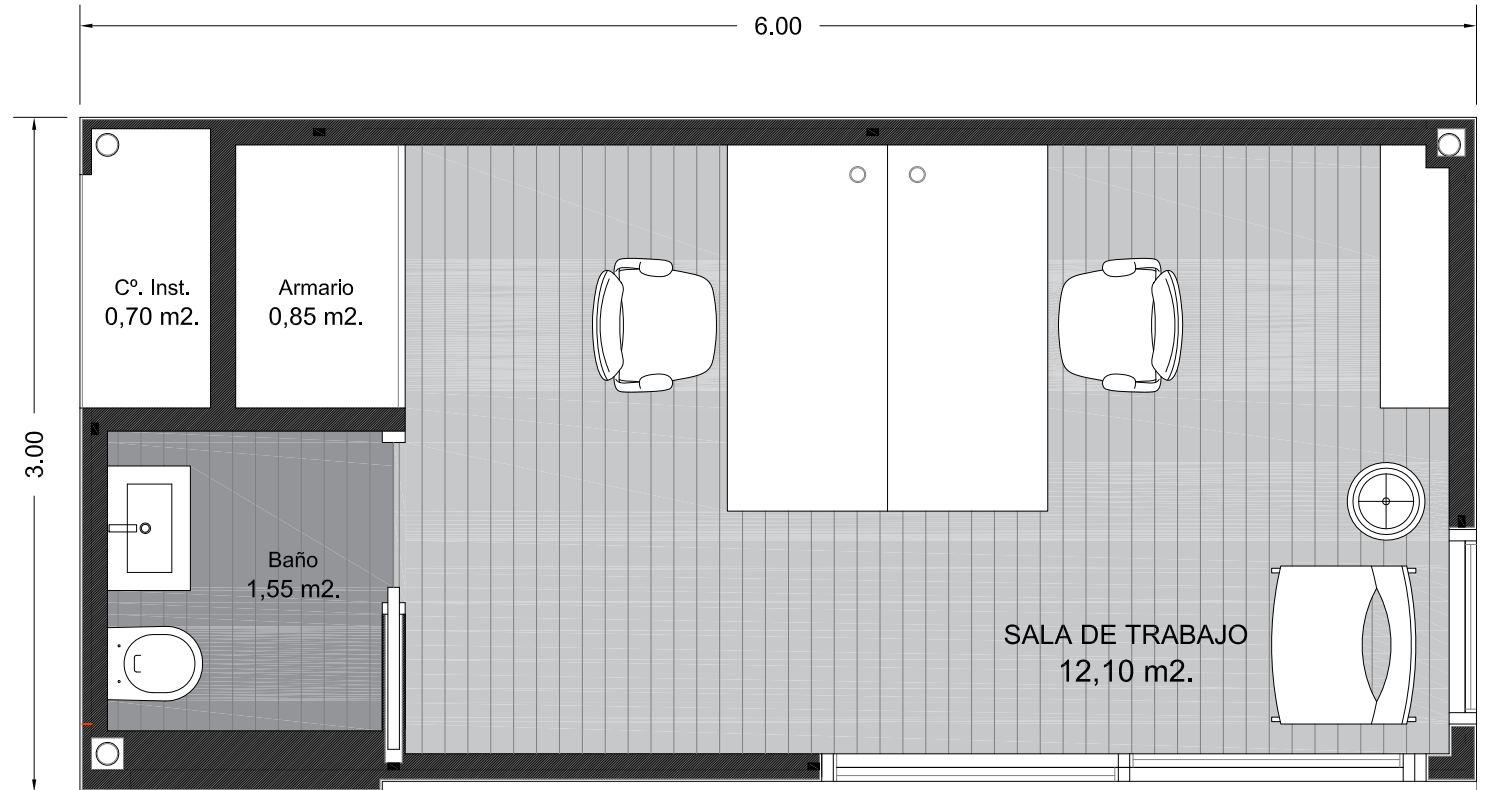

Alzado principal



Alzado lateral

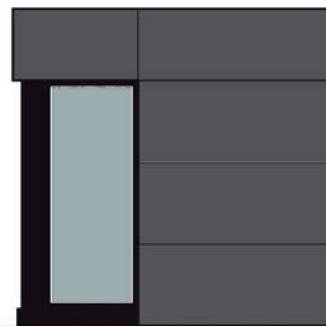

Space Garden
by Resan

Space Garden
by Resan
Modelo DESPACHO
18,00 m²

SG 18 DESPACHO

CUADRO DE SUPERFICIES

SUPERFICIES ÚTILES

Gimnasio 15,12 m².
Cº. Inst. 0,45 m².

15,57 m².

MÓDULO SPORT: 15,57 m².

Total Superficie MÓDULO: 18,00 m².

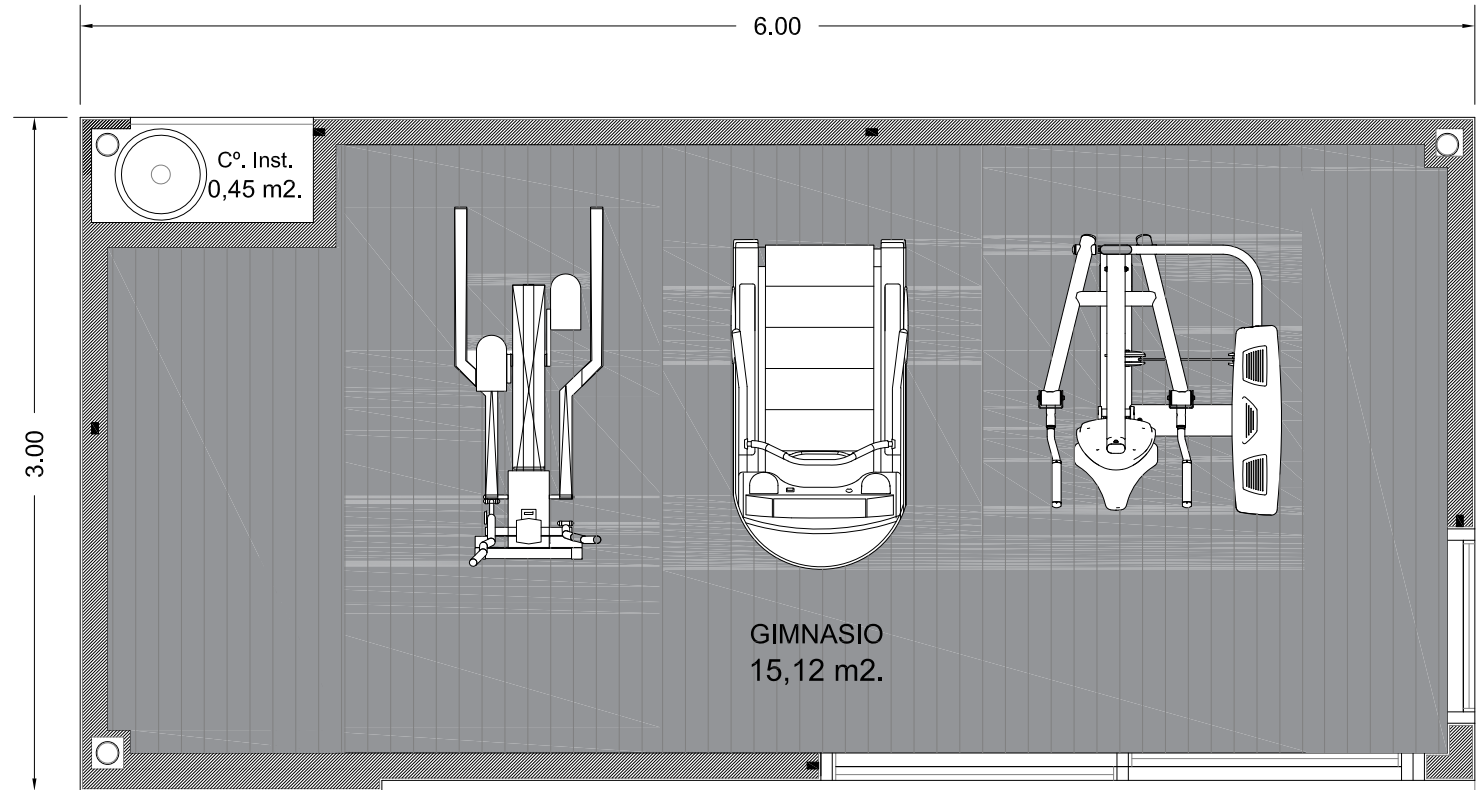

Alzado principal



Alzado lateral

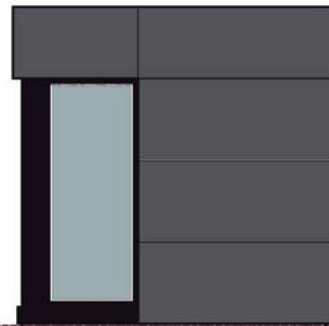

Space Garden
by Resan

Space Garden
by Resan
Modelo GIMNASIO
18,00 m²

SG 18 GIMNASIO

CUADRO DE SUPERFICIES

SUPERFICIES ÚTILES

Gimnasio	11,75 m ² .
Armario	0,70 m ² .
Baño	2,30 m ² .
C°. Inst.	0,45 m ² .

15,20 m².

MÓDULO SPORT: 15,20 m².

Total Superficie MÓDULO: 18,00 m².

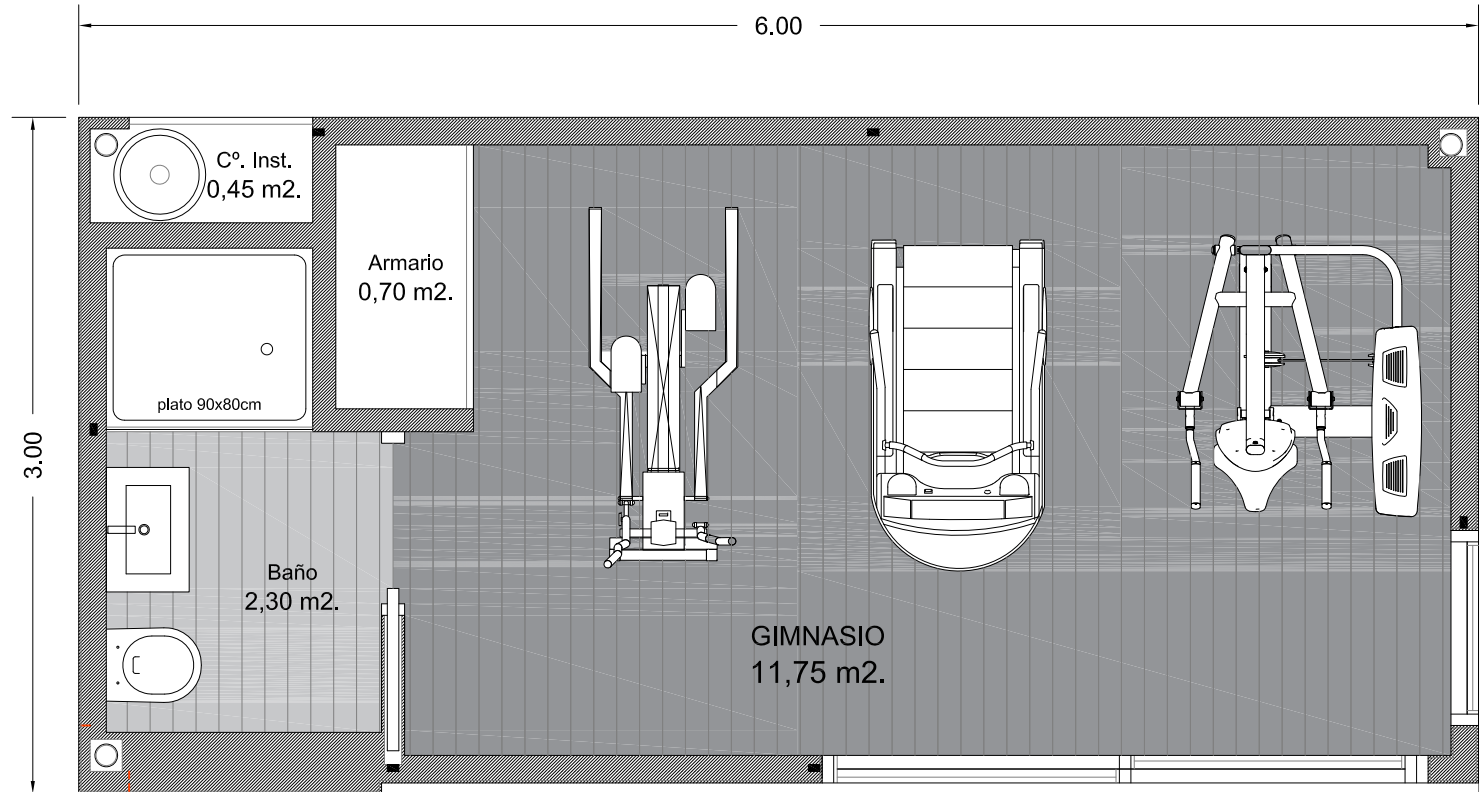

Alzado principal



Alzado lateral

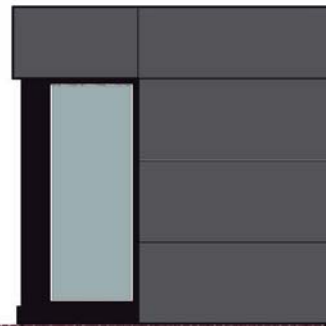

Space Garden
by Resan
Modelo GIMNASIO
18,00 m²

SG 18 GIMNASIO

CUADRO DE SUPERFICIES

SUPERFICIES ÚTILES

Dormitorio	11,75 m ² .
Armario	0,70 m ² .
Baño	2,30 m ² .
C°. Inst.	0,45 m ² .

15,20 m².

MÓDULO SUITE: 15,20 m².

Total Superficie MÓDULO: 18,00 m².

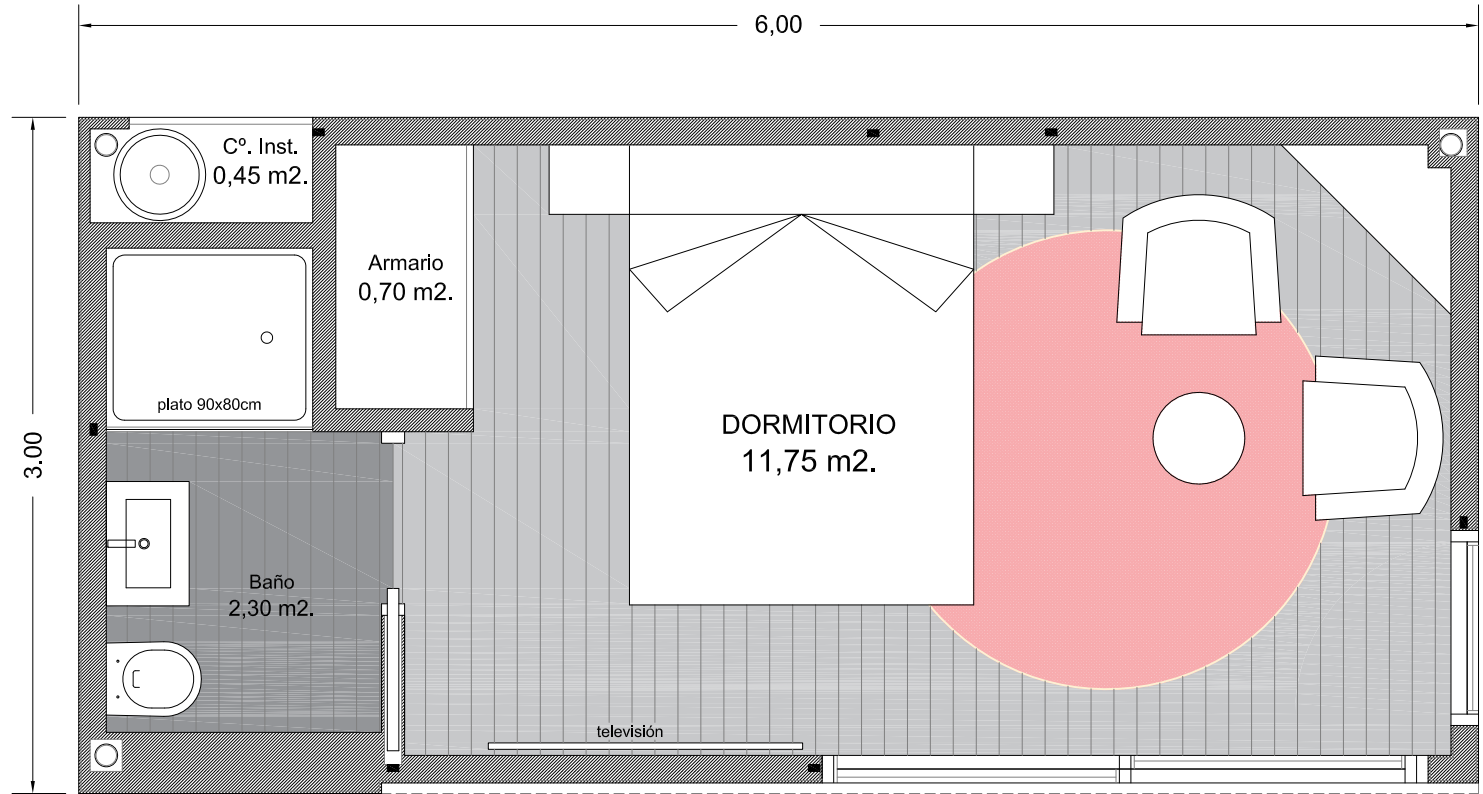

Alzado principal



Alzado lateral

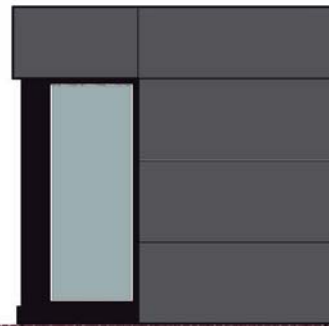

Space Garden
by Resan
Modelo SUITE
18,00 m²

SG 18 SUITE